

**Tosun**<sub>LUX</sub> *Trustable Brand in 91 Countries*

 **Add:** Birnbauismühle 65, 15234 Frankfurt Oder, Germany

 **Factory Add:** Yangwen Industrial Zone, Wenzhou, Zhejiang Province, China

**Office Add:** Room No.1001, Fortune Center, Station Road, Wenzhou, China

**E-mail:** ceo@tosun.com

**Http:** //www.tosunlux.eu

Distributor

*The most reliable  
solution to electric*



# Contents

P1-2	LED Down Light
P3-4	LED Backlit Panel Light
P5-6	Recessed Mount LED Panel Light
P7-8	Surface Mounted LED Panel Light
P9-10	LED Square Panel Light
P11-18	LED Bulb
P19-22	LED Filament Lamp
P23	LED Spotlight
P24	LED Microwave Tube
P25-26	LED Tube
P27-28	LED Batten Fixture
P29-30	LED Batten Light
P31	T5 LED Batten Light
P32	T8 LED Batten Light
P33-34	LED Tri-proof Light Fixture
P35-36	High Bay Light Fixture
P37-38	Humidity Proof Light
P39-40	LED High Bay Light
P41-42	LED Flood Light
P43-44	LED Flood Light with PIR Sensor
P45-47	LED Flood Light
P48	Rechargeable LED Flood Light
P49-50	LED Solar Flood Light
P51-52	LED Street Light
P53-54	LED Solar Street Light
P55-56	Low Voltage LED Strip Light
P57-58	High Voltage LED Strip Light
P59	LED Neon Light



The most reliable solution to electric



## LED Down Light

### Recessed Mount LED Down Light

Model	Power	Voltage	LED Type	Color Temperature	Lamp Size	Material	Driver Type
TRM-RT-6W	6W				95x23mm		
TRM-RT-9W	9W				118x23mm		
TRM-RT-12W	12W	AC180-265V	SMD2835	2700-6500K	145x23mm	Iron with powder coating	DOB
TRM-RT-18W	18W				185x23mm		
TRM-RT-22W	22W				220x23mm		

### Surface Mounted LED Down Light

Model	Power	Voltage	LED Type	Color Temperature	Lamp Size	Material	Driver Type
TSM-RT-18W	18W				165x30mm		
TSM-RT-18W	18W	AC180-265V	SMD2835	2700-6500K	200x35mm	Iron with powder coating	DOB
TSM-RT-22W	22W				200x35mm		

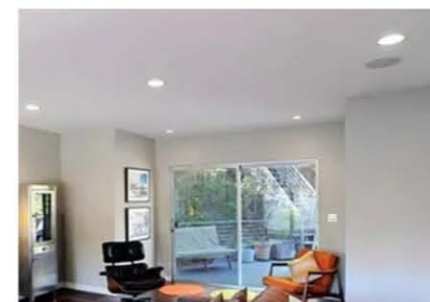

## LED Backlit Panel Light

### Recessed Mount LED Backlit Panel Light

Model	Power	Voltage	LED Type	LED Qty	CRI	Color Temperature	Diameter	Max.hole dia	Driver Type
TRD-RP-9W	9W			45pcs			90mm	65mm	
TRD-RP-18W	18W			90pcs			120mm	100mm	
TRD-RP-24W	24W			144pcs			170mm	150mm	
TRD-RP-36W	36W	AC85-265V/ AC165-265V	SMD2835	252pcs	70Ra/80Ra	2700-6500K	225mm	200mm	Isolated/ non-isolated
TRD-SP-9W	9W			50pcs			90mm	65mm	
TRD-SP-18W	18W			90pcs			120mm	110mm	
TRD-SP-24W	24W			168pcs			170mm	150mm	
TRD-SP-36W	36W			288pcs			225mm	200mm	

### Surface Mounted LED Backlit Panel Light

Model	Power	Voltage	LED Type	LED Qty	CRI	Color Temperature	Size	Driver Type
TSD-RP-18W	18W			90pcs			120x25mm	
TSD-RP-24W	24W	AC85-265V/ AC165-265V	SMD2835	114pcs	70Ra/80Ra	2700-6500K	175x25mm	Isolated/ non-isolated
TSD-RP-36W	36W			252pcs			225x25mm	





## Recessed Mount LED Panel Light

Model	Power	Voltage	Size	Open Size	LED Type	LED Qty	Color Temperature	CRI	Driver Type
TRM-RP-3W	3W	AC85-265V/ AC165-265V	Ø80mm	Ø65mm	SMD2835	15pcs	2700-6500K	70Ra/80Ra	Isolated/ non-isolated driver
TRM-RP-6W	6W		Ø120mm	Ø105mm		30pcs			
TRM-RP-9W	9W		Ø145mm	Ø120mm		45pcs			
TRM-RP-12W	12W		Ø170mm	Ø150mm		60pcs			
TRM-RP-15W	15W		Ø190mm	Ø175mm		75pcs			
TRM-RP-18W	18W		Ø225mm	Ø200mm		90pcs			
TRM-RP-24W	24W		Ø300mm	Ø275mm		120pcs			
TRM-RP-30W	30W		Ø300mm	Ø275mm		150pcs			

Model	Power	Voltage	Size	Open Size	LED Type	LED Qty	Color Temperature	CRI	Driver Type
TRM-SP-3W	3W	AC85-265V/ AC165-265V	80x80mm	70x70mm	SMD2835	15pcs	2700-6500K	70Ra/80Ra	Isolated/ non-isolated driver
TRM-SP-6W	6W		120x120mm	105x105mm		30pcs			
TRM-SP-9W	9W		145x145mm	130x130mm		45pcs			
TRM-SP-12W	12W		170x170mm	150x150mm		60pcs			
TRM-SP-15W	15W		190x190mm	170x170mm		75pcs			
TRM-SP-18W	18W		225x225mm	205x205mm		90pcs			
TRM-SP-24W	24W		300x300mm	275x275mm		120pcs			
TRM-SP-30W	30W		300x300mm	275x275mm		150pcs			



## Surface Mounted LED Panel Light

Model	Power	Voltage	Size	LED Type	LED Qty	Color Temperature	CRI	Driver Type
TSM-RP-6W	6W		Ø120x40mm		30pcs			
TSM-RP-12W	12W		Ø170x40mm		60pcs			
TSM-RP-18W	18W	AC85-265V/ AC165-265V	Ø225x40mm	SMD2835	90pcs	2700-6500K	70Ra/80Ra	Isolated/ non-isolated driver
TSM-RP-24W	24W		Ø300x40mm		120pcs			
TSM-RP-30W	30W		Ø300x40mm		150pcs			

Model	Power	Voltage	Size	LED Type	LED Qty	Color Temperature	CRI	Driver Type
TSM-SP-6W	6W		120x120x40mm		30pcs			
TSM-SP-12W	12W		170x170x40mm		60pcs			
TSM-SP-18W	18W	AC85-265V/ AC165-265V	220x220x40mm	SMD2835	90pcs	2700-6500K	70Ra/80Ra	Isolated/ non-isolated driver
TSM-SP-24W	24W		300x300x40mm		120pcs			
TSM-SP-30W	30W		300x300x40mm		150pcs			

## LED Square Panel Light

Model	Power	Voltage	PF	LED Type	CRI	Color Temperature	Luminous Efficiency	Size
TPL-30120-40W	40W							1195x295x10mm
TPL-6060-40W	40W							595x595x10mm
TPL-6060-48W	48W	AC85-265V/ AC170-240V	>0.9	SMD4014	80Ra	2700-6500K	>80LMW	595x595x10mm
TPL-60120-60W	60W							1195x595x10mm
TPL-60120-72W	72W							1195x595x10mm
TSP-6060-40W	40W							595x595x36mm
TSP-6060-48W	48W							595x595x36mm

## LED Square Backlit Panel Light

Model	Power	Voltage	PF	LED Type	CRI	Color Temperature	Luminous Efficiency	Size
DPL-6060-45W	45W						>80LMW	
DPL-6060-55W	55W							595x595x20mm
DPL-6060-65W	65W	AC175-265V	0.5	SMD3535	>80Ra	2700-6500K	>90LMW	
DSP-6060-45W	45W							
DSP-6060-55W	55W							
DSP-6060-65W	65W						>90LMW	

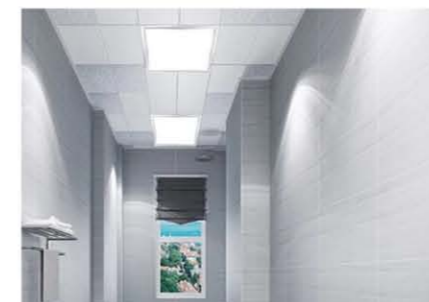

## LED Bulb

Model	Power	Voltage	Base	LED Type	CRI	Color Temperature	Size	Material	Driver Type
G45-5W	5W						Ø45		
G45-6W	6W	AC85-265V/ AC165-265V					Ø45		
A60-7W	7W						Ø60		
A60-9W	9W	AC85-265V/ AC165-265V/ DC12-24V	E27/B22	SMD2835	>80Ra	2700-6500K	Ø65	Plastic+Aluminum	DOB/separated IC
A65-12W	12W						Ø70		
A70-15W	15W	AC85-265V/ AC165-265V					Ø80		
A80-18W	18W						Ø95		







## LED Bulb

Model	Power	Voltage	Base	LED Type	CRI	Color Temperature	Size	Material
CA35-6W	6W	AC85-265V/ AC165-265V	E14	SMD2835	>80Ra	2700-6500K	Ø37x111mm	Plastic+Aluminum
CA37-6W							Ø37x138mm	

## LED Bulb



### LED RGB Bulb

Model	Power	Voltage	Base	Color	Lumen	Control Distance	Size
RGB+W	7W	AC170-260V	E27/B22	16 colors	560LM	5-8m	Ø60x110mm



### Microwave Sensor LED Bulb

Model	Power	Voltage	Base	Lumen	Induction Range	Size
TSLSB	9W	AC170-260V	E27/B22	720LM	5-8m	Ø60x110mm

Delay time	Light up
30-45s(adjustable up to 2 mins)	Environment brightness lower than 10 lux with human motion



### Emergency LED Bulb

Model	Power	Voltage	Base	Lumen	Battery	Size
TSEB-5W	5W	AC170-250V	E27/B22	400LM	5H	Ø80x159mm
TSEB-7W	7W			560LM		Ø70x145mm
TSEB-9W	9W			680LM		Ø80x159mm

## LED Bulb



TB-T2



TB-T1

Model	Power	Voltage	Base	LED Type	CRI	Color Temperature	Size	Material
TB-T1-5W	5W	AC85-265V/ AC165-265V	E27/B22	SMD2835	>80Ra	2700-6500K	Ø50	Aluminum+PC
TB-T1-9W	9W						Ø60	
TB-T1-13W	13W						Ø70	
TB-T1-18W	18W						Ø80	
TB-T1-26W	26W						Ø100	
TB-T1-36W	36W						Ø120	
TB-T1-48W	48W						Ø135	

Model	Power	Voltage	Base	LED Type	CRI	Color Temperature	Size	Material
TB-T2-5W	5W	AC85-265V/ AC165-265V	E27/B22	SMD2835	>80Ra	2700-6500K	Ø50	Aluminum+PC
TB-T2-9W	9W						Ø60	
TB-T2-13W	13W						Ø70	
TB-T2-18W	18W						Ø80	
TB-T2-25W	25W						Ø100	
TB-T2-34W	34W						Ø115	
TB-T2-43W	43W						Ø125	
TB-T2-54W	54W						Ø135	
TB-T2-72W	72W						Ø150	

# LED Bulb



Model	Power	Base	Voltage	PF	CRI	Lumen	Beam Angel	Color Temperature	Size
TS-ED-30W	30W	E27/B22	AC100-265V/ AC180-240V	>0.5/0.9	>80Ra	3300LM	270°	2700-6500K	Ø90x218mm
TS-ED-40W	40W					4400LM			
TS-ED-50W	50W					5500LM			
TS-ED-60W	60W	E40	AC100-265V/ AC180-240V	>0.5/0.9	>80Ra	6600LM	270°	2700-6500K	Ø120x285mm
TS-ED-70W	70W					7700LM			
TS-ED-80W	80W					8800LM			
TS-ED-100W	100W					11000LM			

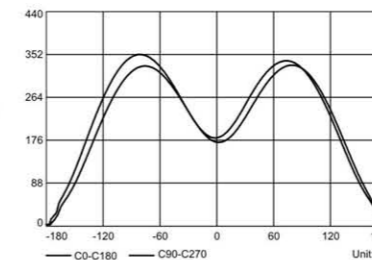
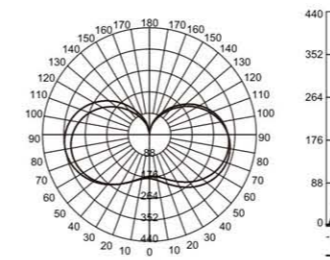

30W

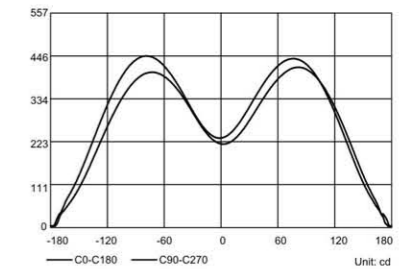
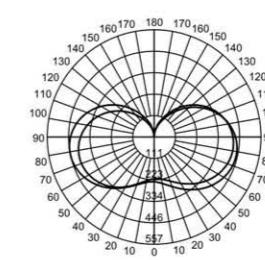

40W

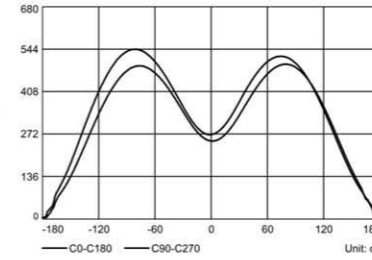
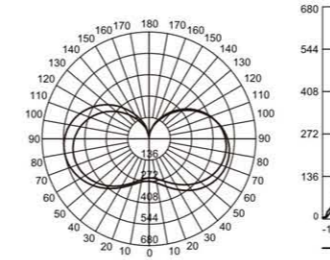

50W

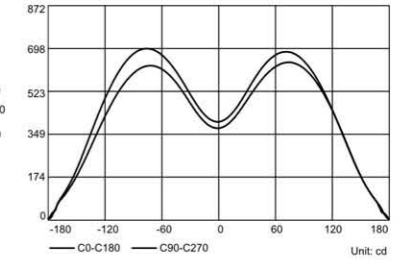
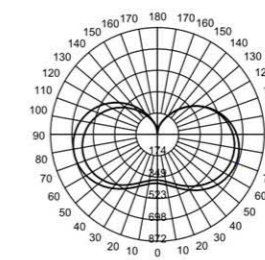

60W

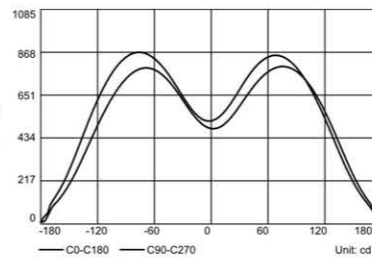
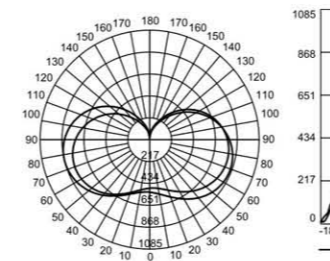

70W

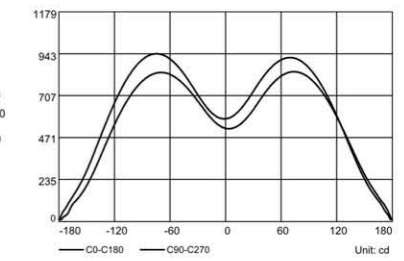
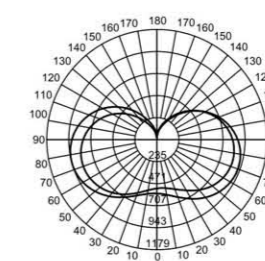

80W

# LED Filament Lamp



Color temperature parameter



Model	Power	Filament Shape	Base	Voltage	CRI	Lumen	Beam Angel	LEDs	Color Temperature	Glass	Size
C35-2W	2W	Curve	E14/BA15	AC110-130V/ AC220-240V	80Ra/90Ra	100LM	360°	1	2200K	Clear/Amber/Grey	Ø35x100mm
C35T-2W											
ST64-3W	3W	Single loop	E27/B22	AC100-265V/ AC220-240V	80Ra/90Ra	100LM	360°	2	2200K	Clear/Amber/Grey	Ø64x146mm
ST64-5W	5W	Spiral									
ST64-5W	5W	Twin loop									
T45-5W	5W	Spiral									
T30-5W	5W	Spiral									Ø30x150mm

Model	Power	Filament Shape	Base	Voltage	CRI	Lumen	Beam Angel	LEDs	Color Temperature	Glass	Size
A60-3W	3W	Curve	E27/B22	AC100-265V/ AC220-240V	80Ra/90Ra	150LM	360°	1	2200K	Clear/Amber	Ø60x105mm
G45-2W	2W	Curve	E14/BA15	AC110-130V/ AC220-240V							
G95-5W	5W	Quad loop	E27/B22	AC100-265V/ AC220-240V	80Ra/90Ra	250LM	360°	2	2200K	Clear/Amber/Grey	Ø95x135mm
G95-5W	5W	Twin loop									
G95-5W	5W	Spiral									
G125-5W	5W	Spiral									
G125-5W	5W	Quad loop									
G125-5W	5W	Twin loop									Ø125x175mm

# LED Filament Lamp

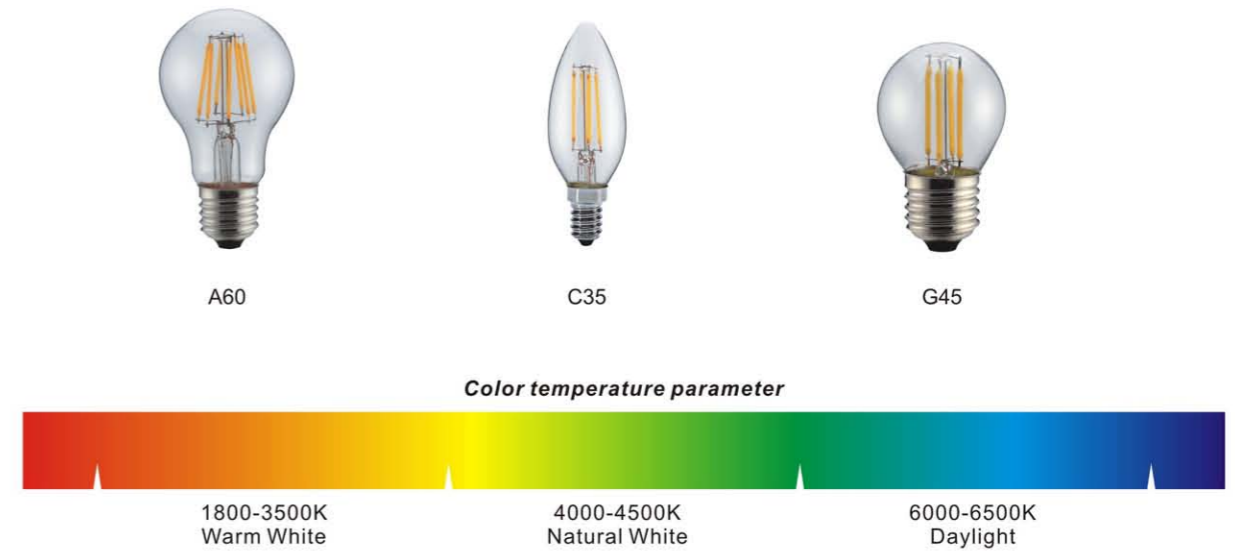

Remark: The glass cover can be: clear, frost, white, amber

Model	Power	Base	Voltage	CRI	Lumens	LEDs	Color Temperature	Size(mm)
G80/G95/G125-2W	2W	E27/B22	AC220-240V	80Ra/90Ra	220LM	2	2700K	80x120 / 95x135 / 125x175
G80/G95/G125-4W	4W		AC100-265V/ AC220-240V		470LM	4		
G80/G95/G125-6W	6W		800LM		6			
G80/G95/G125-8W	8W		1000LM		8			
G80/G95/G125-10W	10W		1200LM		12			

Model	Power	Base	Voltage	CRI	Lumens	LEDs	Color Temperature	Size(mm)
ST58/ST64-2W	2W	E27/B22	AC220-240V	80Ra/90Ra	220LM	2	2700K	58x130 / 64x146
ST58/ST64-4W	4W		AC100-265V/ AC220-240V		470LM	4		
ST58/ST64-6W	6W		800LM		6			
ST58/ST64-8W	8W		1000LM		8			

Model	Power	Base	Voltage	CRI	Lumens	LEDs	Color Temperature	Size(mm)	Dimmable
A60-2W	2W	E27/B22	AC220-240V	80Ra/90Ra	220LM	2	2700K	Ø65x105	No
A60-4W	4W		AC100-265V/ AC220-240V		450LM	4			
A60-6W	6W		800LM		6				
A60-8W	8W		1000LM		8	Yes			
A60-5W	5W		AC220-240V		550LM				4
A60-8W	8W		950LM		8				

Model	Power	Base	Voltage	CRI	Lumens	LEDs	Color Temperature	Size(mm)	Dimmable
C35-1W	1W	E14/E27	AC220-240V	80Ra/90Ra	100LM	1	2700K	Ø35x98	No
C35-2W	2W		AC110-130V/ AC220-240V		230LM	2			
C35-4W	4W		440LM		4				
G45-1W	1W		AC220-240V		100LM	1			No
G45-2W	2W		AC110-130V/ AC220-240V		230LM	2			
G45-4W	4W		AC220-240V		440LM	4			



TSP-A

TSP-B

## LED Spotlight

Model	Power	Base	Voltage	LED Type	Color Temperature	Material	Size
TSP-3W	3W	GU10/GU5.3	AC170-265V/	SMD2835	2700-6500K	Thermoplastic+ Aluminum	Ø50x55mm
TSP-5W	5W		AC220-240V/				
TSP-7W	7W		DC12V/DC24V				

## LED Microwave Tube

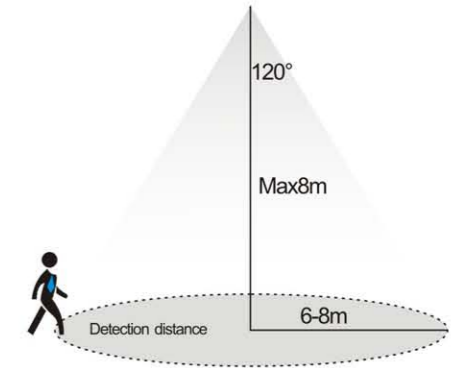

Model	Power	Voltage	LED Type	CRI	PF	Color Temperature	Luminous Efficiency	Size	Sensor type	Material
T8S-9W	9W							Ø26xL598mm		
T8S-18W	18W	AC85-265V/ AC175-265V	SMD2835	>80Ra	>0.5/>0.9	2700-6500K	120LM/W	Ø26xL1298mm	Microwave	Aluminum+PC
T8S-22W	22W							Ø26xL1498mm		



## LED Tube



Model	Power	Voltage	LED Type	CRI	PF	Color Temperature	Size	Material
TNP-T8L6-9W	9W						Ø26xL598mm	
TNP-T8L12-18W	18W	AC85-265V/ AC175-265V	SMD2835	>70Ra/>80Ra	>0.5/>0.9	2700-6500K	Ø26xL1298mm	Nano Plastic
TNP-T8L15-21W	21W						Ø26xL1498mm	

Model	Power	Voltage	LED Type	CRI	PF	Color Temperature	Size	Material
TT-T8L6-9W	9W						Ø26x598mm	
TT-T8L12-18W	18W	AC85-265V/ AC175-265V	SMD2835	>70Ra	>0.5	2700-6500K	Ø26x1298mm	Glass
TT-T8L15-24W	24W						Ø26x1498mm	



# LED Batten Fixture

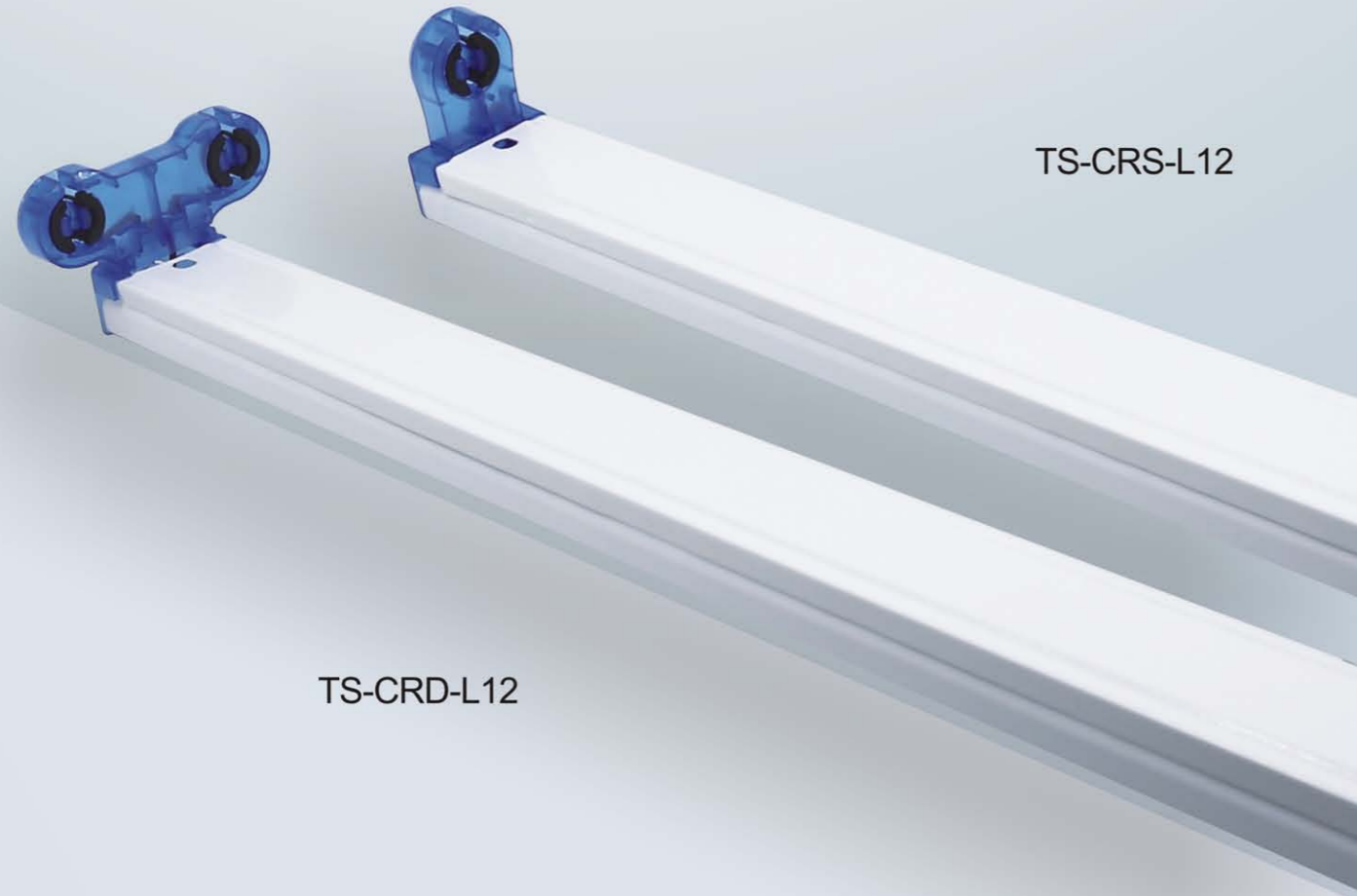

TS-CRS-L12

TS-CRD-L12

Model	Power(LED)	Body Material	Bracket	Size
TS-CRS-L6	9W	Iron with powder coating	Crystal holder foldable, ABS	609 x 34 x 50mm
TS-CRS-L9	15W			912 x 34 x 50mm
TS-CRS-L12	18W			1230 x 34 x 50mm

Model	Power(LED)	Body Material	Bracket	Size
TS-CRD-L6	2x9W	Iron with powder coating	Crystal holder foldable, ABS	609 x 34 x 50mm
TS-CRD-L9	2x15W			912 x 34 x 50mm
TS-CRD-L12	2x18W			1230 x 34 x 50mm

Model	Power(LED)	Body Material	Bracket	Size
TS-8001S-L6	9W	Iron with powder coating	Integrated ABS/PP	620 x 35 x 43mm
TS-8001S-L12	18W			1220 x 35 x 43mm
TS-8001S-L15	24W			1520 x 35 x 43mm

Model	Power(LED)	Body Material	Bracket	Size
TS-8001D-L6	2 x 9W	Iron with powder coating	Integrated ABS	620 x 35 x 43mm
TS-8001D-L12	2 x 18W			1220 x 35 x 43mm
TS-8001D-L15	2 x 24W			1520 x 35 x 43mm



TS-8001D-L12



TS-8001S-L6



# LED Batten Light

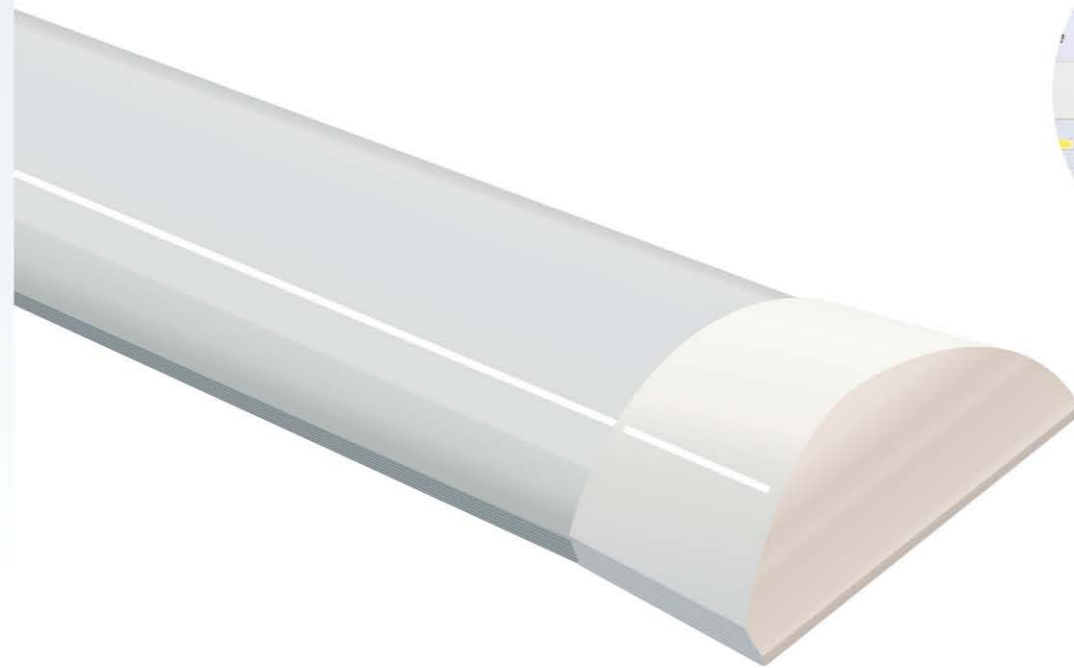

Model	Power	Voltage	LED Type	Luminous Efficiency	PF	CRI	Color Temperature	Lampshade	Material
AMB-L6-18W	18W			>90LMW					
AMB-L12-50W	50W	AC185-265V	SMD2835	>100LMW	>0.5	>70Ra	2700-6500K	Milky/Prismatic	Coated Steel
AMB-L12-68W	68W			>100LMW					

Model	Power	Voltage	LED Type	Luminous Flux	PF	CRI	Color Temperature	Length	Material
TA-CL6-18W	18W	AC85-265V/ AC180-265V	SMD2835	1500LM	>0.5/>0.9	>80Ra	2700-6500K	600mm	Aluminum
TA-CL12-36W	36W			2800LM				1200mm	
TB-CL6-18W	18W	AC180-265V	SMD2835	1500LM	>0.5	>70Ra	2700-6500K	600mm	Steel
TB-CL12-36W	36W			2800LM				1200mm	

## T5 LED Batten Light



Model	Power	Voltage	LED Type	Color Temperature	Size	Material
TS-1301L-4W	4W	AC170-265V	SMD2835	2700-6500K	292x22x30mm	Aluminum+PC
TS-1301L-8W	8W				574x22x30mm	
TS-1301L-10W	10W				874x22x30mm	
TS-1301L-14W	14W				1006x22x30mm	
TS-1301L-16W	16W				1166x22x30mm	

## T8 LED Batten Light

Model	Power	Voltage	LED Type	CRI	PF	Color Temperature	Material
TS-9001L-10W	10W	AC85-265V	SMD2835	>80Ra	0.95	2700-6500K	Aluminum+PC
TS-9001L-18W	18W						
TS-9001L-22W	22W						

## LED Tri-proof Light Fixture

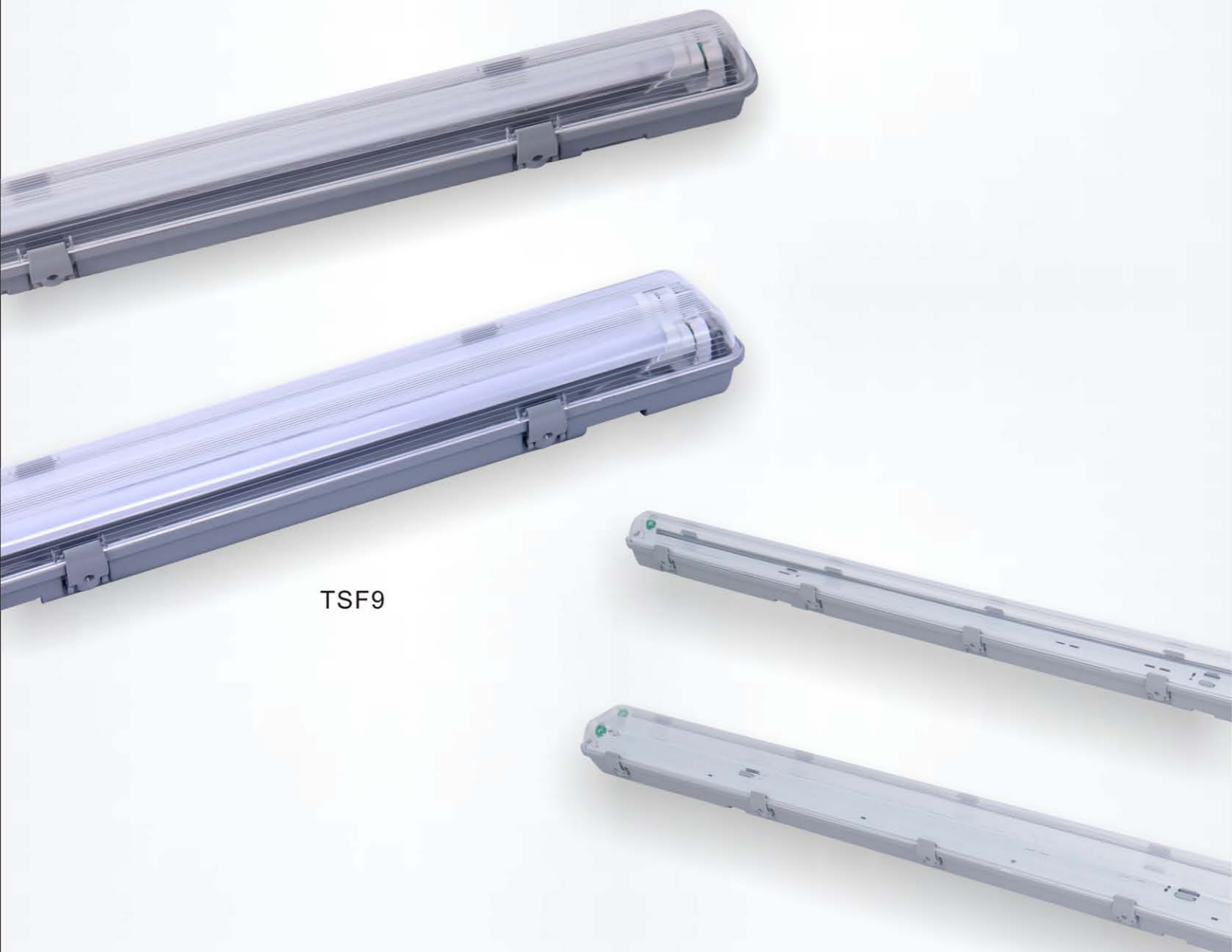

TSF9

TSF8

Model	Power	L x W x H	Clips
TSF8	1 x 9W	660 x 65 x 85mm	4
TSF8	2 x 9W	660 x 105 x 85mm	4
TSF8	1 x 18W	1265 x 65 x 85mm	10
TSF8	2 x 18W	1265 x 105 x 85mm	10
TSF8	1 x 21W	1565 x 70 x 85mm	12
TSF8	2 x 21W	1565 x 105 x 85mm	12

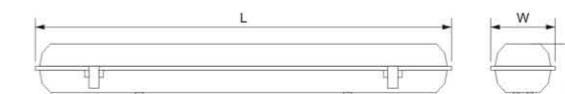

Model	Power	L x W x H	Clips
TSF9	1x9W	660x80x70mm	4
TSF9	2x9W	660x125x70mm	4
TSF9	1x18W	1265x80x70mm	10
TSF9	2x18W	1265x125x70mm	10

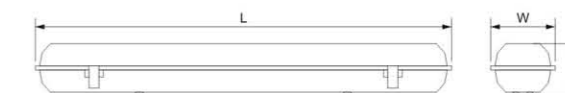



# High Bay Light Fixture

## PC Reflector

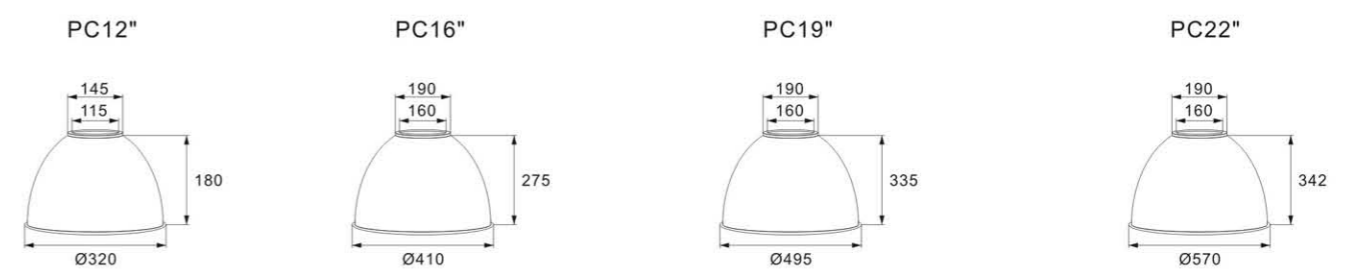

## PC Cover

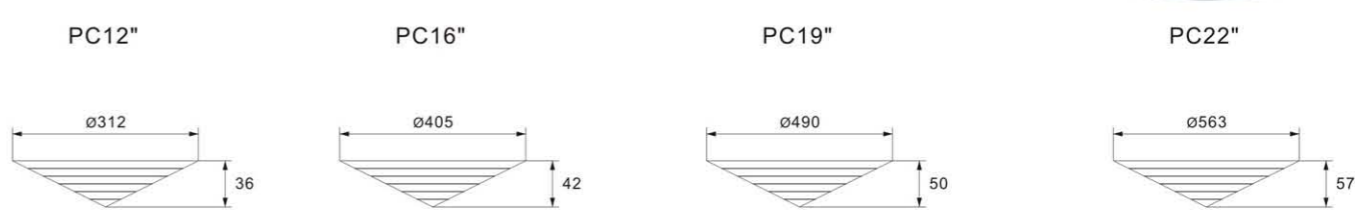

## Steel Ring



12" Circle      16" Circle      19" Circle      22" Circle

## Metal Holder

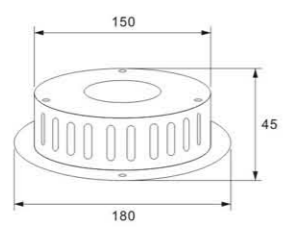

## Gear Box E27/E40

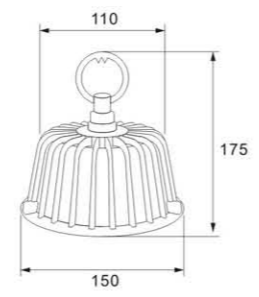



- Aluminium die-casting body
- Clear/frost glass diffuser
- Voltage: AC100-240V 50/60Hz
- E27/60W, CFL/9W
- E27/100W, CFL/13W
- IP43

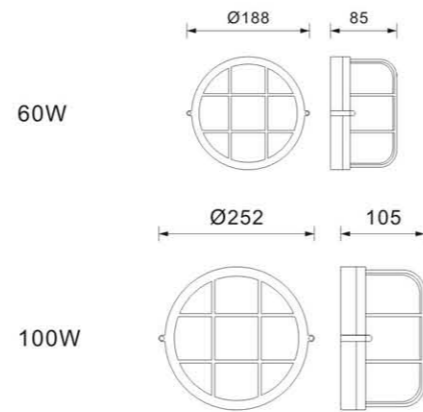
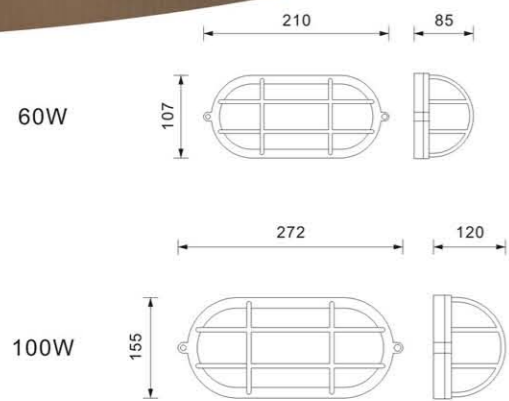

**TS-9001A**  
60W/100W



**TS-9002A**  
60W/100W



**TS-9005A**  
60W/100W



**TS-9007A**  
60W/100W



**TS-9009A**  
60W/100W



**TS-9010A**  
60W/100W



**TS-9013A**  
60W/100W



**TS-9015A**  
60W/100W



## Humidity Proof Light



Model	Power	Voltage	LED Type	LED Qty	Size	Lumen	CRI	IP
TS-FCR 8W	8W	AC170-265V	SMD2835	36pcs	Ø125x55mm	760LM	>70Ra	IP54
TS-FCR 12W	12W			36pcs	Ø140x55mm	1150LM		
TS-FCR 18W	18W			72pcs	Ø160x55mm	1750LM		
TS-FCR 20W	20W			108pcs	Ø172x55mm	1900LM		
TS-FCR 24W	24W			108pcs	Ø220x55mm	2300LM		

Model	Power	Voltage	LED Type	LED Qty	Size	Lumen	CRI	IP
TS-FCE 8W	8W	AC170-265V	SMD2835	28pcs	136x62x55mm	760LM	>70Ra	IP54
TS-FCE 12W	12W			36pcs	157x68x55mm	1150LM		
TS-FCE 18W	18W			48pcs	183x83x55mm	1750LM		
TS-FCE 20W	20W			48pcs	183x83x55mm	1900LM		
TS-FCE 24W	24W			64pcs	250x120x48mm	2300LM		



## LED High Bay Light

Model	TS-UFO-8002-100W	TS-UFO-8002-150W	TS-UFO-8002-200W
Power	100W	150W	200W
Voltage	AC220-240V		
LED Type	SMD2835		
LED Quantity	144PCS	210PCS	280PCS
Lumen	9000LM	13500LM	18000LM
Beam Angle	120°		
Color Temperature	2700-6500K		
CRI	70Ra		
Material	Die-casting Aluminum		
Product Size	Ø280x280x55mm	Ø340x340x55mm	Ø400x400x58mm
Wire Type	Rubber wire ≥200mm		
IP Grade	IP65		
Working Life	≥20000H		
Ambient Temperature Range	-25°C-+45°C		
Ambient Humidity Range	≤95%RH		

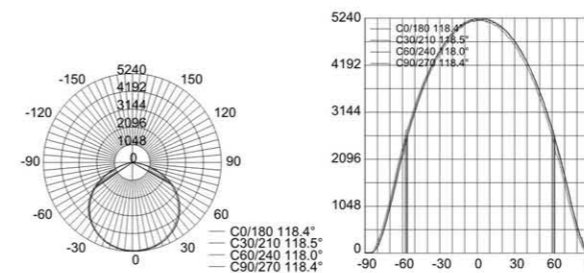

150W

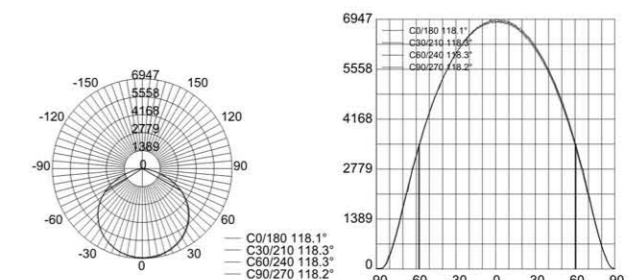

200W

# LED Flood Light



Model	Power	Voltage	Driver Type	PF	CRI	Color Temperature	Luminous Efficiency
TF-10W	10W	AC220-240V	Linear	>0.9	>80Ra	2700-6500K	>80LM/W
TF-20W	20W						
TF-30W	30W						
TF-50W	50W						
TF-70W	70W						
TF-100W	100W						
TF-150W	150W						
TF-200W	200W						
TF-300W	300W						
TF-400W	400W						



# LED Flood Light with PIR Sensor



Model	Power	Voltage	Driver Type	PF	CRI	Color Temperature	Luminous Efficacy
TF-20W-D	20W	AC220-240V	Linear	>0.9	>80Ra	2700-6500K	>80LM/W
TF-30W-D	30W						
TF-50W-D	50W						
TF-70W-D	70W						

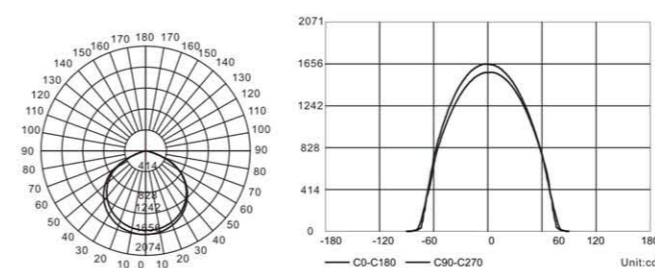

50W

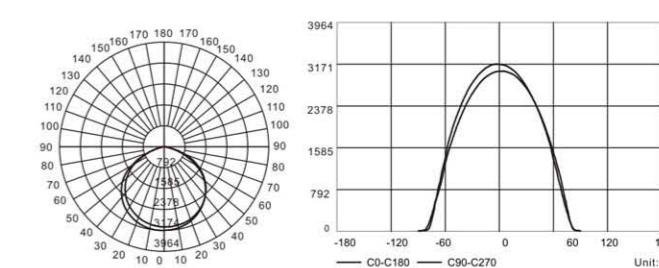

100W





## LED Flood Light



Model	Power	Voltage	PF	LED Type	CRI	Color Temperature	Luminous Efficiency	Driver Type
TF-SMD-B-50W	50W							
TF-SMD-B-100W	100W							
TF-SMD-B-150W	150W							
TF-SMD-B-200W	200W	AC85-265V	>0.95	SMD3030	>70Ra	2700-6500K	90LM/W	Isolated driver
TF-SMD-B-300W	300W							
TF-SMD-B-400W	400W							
TF-SMD-B-500W	500W							





(with AC/DC adapter & car charger)

## LED Flood Light

Model	Power	Voltage	PF	LED Type	CRI	Color Temperature	Luminous Efficiency	Driver Type
TF-COB-100W	100W	AC85-265V	>0.95	COB	>70Ra	2700-6500K	90LMW	Isolated driver
TF-COB-150W	150W							
TF-COB-200W	200W							
TF-COB-250W	250W							

## Rechargeable LED Flood Light

Model	Power	Voltage	Battery Capacity	LED Chip	CRI	Color Temperature	Charging Time	Working Time	IP Grade
TS-RFL-10W	10W	AC85-265V/ DC12V	5V 2200mAh X1 18650 Li Battery	COB	>70Ra	2700-6500K	4H	5H	IP65
TS-RFL-20W	20W		5V 2200mAh X2 18650 Li Battery					3.5H	
TS-RFL-30W	30W		5V 2200mAh X4 18650 Li Battery					6H	
TS-RFL-50W	50W		5V 2200mAh X8 18650 Li Battery						



(with lighting control+timing remote control)

## LED Solar Flood Light

Model	Power	LED Chip	CRI	Color Temperature	Battery Capacity	Solar Panel Capacity	Solar Panel Size(mm)	Charging Time	Working Time	IP Grade
TS-SFL-25W	25W				3.2V/5000mAh 32650 lithium	polycrystalline silicon 6V/8W	350x190x17mm			
TS-SFL-40W	40W				3.2V/10000mAh 32650 lithium	polycrystalline silicon 6V/12W	350x290x17mm			
TS-SFL-60W	60W	SMD2835 /5730	>70Ra	2700-6500K	3.2V/15000mAh 32650 lithium	polycrystalline silicon 6V/15W	350x350x17mm	3-4H	12-18H	IP65
TS-SFL-100W	100W				3.2V/25000mAh 32650 lithium	polycrystalline silicon 6V/25W	530x350x17mm			
TS-SFL-200W	200W				3.2V/30000mAh 32650 lithium	polycrystalline silicon 6V/30W	600x350x17mm			



## LED Street Light

Model	Power	Voltage	PF	Driver Type	LED Type	CRI	Color Temperature	Luminous Efficiency	IP Grade	Product Size	Material
TS-SMD-FH-50W	50W									380×160×75mm	
TS-SMD-FH-100W	100W	AC85-265V	>0.9	Isolated driver	SMD3030	>70Ra	2700-6500K	>100LM/W	IP65	505×205×75mm	Dia-casting Aluminum
TS-SMD-FH-150W	150W									600×260×75mm	

Model	Power	Voltage	PF	Driver Type	LED Type	CRI	Color Temperature	Luminous Efficiency	IP Grade	Product Size	Material
TS-SMD-LX-30W	30W									280×135×70mm	
TS-SMD-LX-50W	50W									425×180×80mm	
TS-SMD-LX-60W	60W									425×180×80mm	
TS-SMD-LX-100W	100W	AC85-265V	>0.9	Isolated driver	SMD3030	>70Ra	2700-6500K	>100LM/W	IP65	505×215×80mm	Dia-casting Aluminum
TS-SMD-LX-150W	150W									600×235×85mm	
TS-SMD-LX-200W	200W									655×245×85mm	
TS-SMD-LX-250W	250W									815×305×90mm	

Model	Power	Voltage	PF	Driver Type	LED Type	CRI	Color Temperature	Luminous Efficiency	IP Grade	Product Size	Material
TS-COB-BJ-50W	50W									500×210×75mm	
TS-COB-BJ-100W	100W									700×280×80mm	
TS-COB-BJ-150W	150W	AC85-265V	>0.95	Isolated driver	COB	>70Ra	2700-6500K	>100LM/W	IP65	860×320×80mm	Dia-casting Aluminum
TS-COB-BJ-200W	200W									950×350×80mm	
TS-COB-BJ-250W	250W									1100×335×80mm	



Model	Power	CRI	Color Temperature	Battery Capacity	Solar Panel	Working Time	Product Size	Installation Height	Material
TS-SA-30W	30W	>70Ra	2700-6500K	3.2V 4AH	6V 6W	13H	388x193x46mm	3-4m	ABS engineering plastic
TS-SA-60W	60W			3.2V 8AH	6V 8W		484x218x46mm	5-6m	
TS-SA-90W	90W			3.2V 12AH	6V 12W		620x238x46mm	7m	
TS-SA-120W	120W			3.2V 15AH	6V 15W		720x240x46mm	8m	

Model	Power	CRI	Color Temperature	Battery Capacity	Solar Panel	Working Time	Size	Installation Height	Material
TS-SB-60W	60W	>70Ra	2700-6500K	3.2V 20AH	5V 28W	12-18H	675x280x80mm	5-6m	Dia-casting Aluminum
TS-SA-120W	120W			3.2V 25AH			785x302x80mm	6-7m	

Model	Power	CRI	Color Temperature	Battery Capacity	Solar Panel	Working Time	Size	Installation Height	Material
TS-FT-60W	60W	>70Ra	2700-6500K	3.2V 15AH	6V 15W	12-18H	495x210x50mm	5m	Dia-casting Aluminum
TS-FT-100W	100W			3.2V 20AH	6V 25W			6m	
TS-FT-200W	200W			3.2V 25AH	6V 30W			7m	
TS-FT-300W	300W			3.2V 30AH	6V 35W			8m	



TS-SA

with lighting control+ Radar induction



TS-SB

with lighting control+ timing remote control



TS-FT

with lighting control+ timing remote control

## LED Solar Street Light

## Low Voltage LED Strip Light

Model	Voltage	LED Type	LED Qty	PCB Type	Packing	IP Grade	Color
TSL-2835-60	DC12V	SMD2835	60LEDs / Meter	Single-side/ Double-side	5Meters/Reel	IP20/IP65	
TSL-2835-120			120LEDs / Meter	IP20			
TSL-2835-168			168LEDs / Meter			IP20	
TSL-2835-180			180LEDs / Meter	IP20			
TSL-2835-204			204LEDs / Meter			IP20	
TSL-2835-240			240LEDs / Meter	IP20			
TSL-5050-60			60LEDs / Meter			IP20/IP65	
TSL-5050-30-RGB			SMD5050 30LEDs / Meter				
TSL-5050-60-RGB			60LEDs / Meter				
TSL-5730-60			SMD5073	60LEDs / Meter			



# High Voltage LED Strip Light



Model	Voltage	LED Type	LED Qty	PCB Width	Packing	IP Grade	Color
TSH-2835-60	AC220V	SMD2835	60LEDs / Meter	8mm	100Meters/Roll	IP65	
TSH-2835-120			120LEDs / Meter	10mm			
TSH-2835-180			180LEDs / Meter	12mm			
TSH-2835-276			276LEDs / Meter	15mm			
TSH-5050-60	AC220V	SMD5050	60LEDs / Meter	8mm/10mm	100Meters/Roll	IP65	
TSH-5050-60-RGB			60LEDs / Meter	12mm			
TSH-5730-120	AC220V	SMD5730	120LEDs / Meter	10mm/12mm	100Meters/Roll	IP65	
TSH-3014-120	AC220V	SMD3014	120LEDs / Meter	6mm	100Meters/Roll	IP65	





The most reliable  
solution to electric

## Low Voltage LED Neon Light

Model	Voltage	LED Type	LED Qty	PCB Width	Packing	IP Grade	Material	Size	Color
TSLN-2835-120	DC12V	SMD2835	120LEDs / Meter	6mm	50Meters/Roll 100Meters/Roll	IP65	Silicon	6x12mm	

## High Voltage LED Neon Light

Model	Voltage	LED Type	LED Qty	PCB Width	Packing	IP Grade	Material	Size	Color
TSHN-2835-120	AC220V	SMD2835	120LEDs / Meter	10mm	50Meters/Roll 100Meters/Roll	IP65	PVC	8x16mm	